

fügen

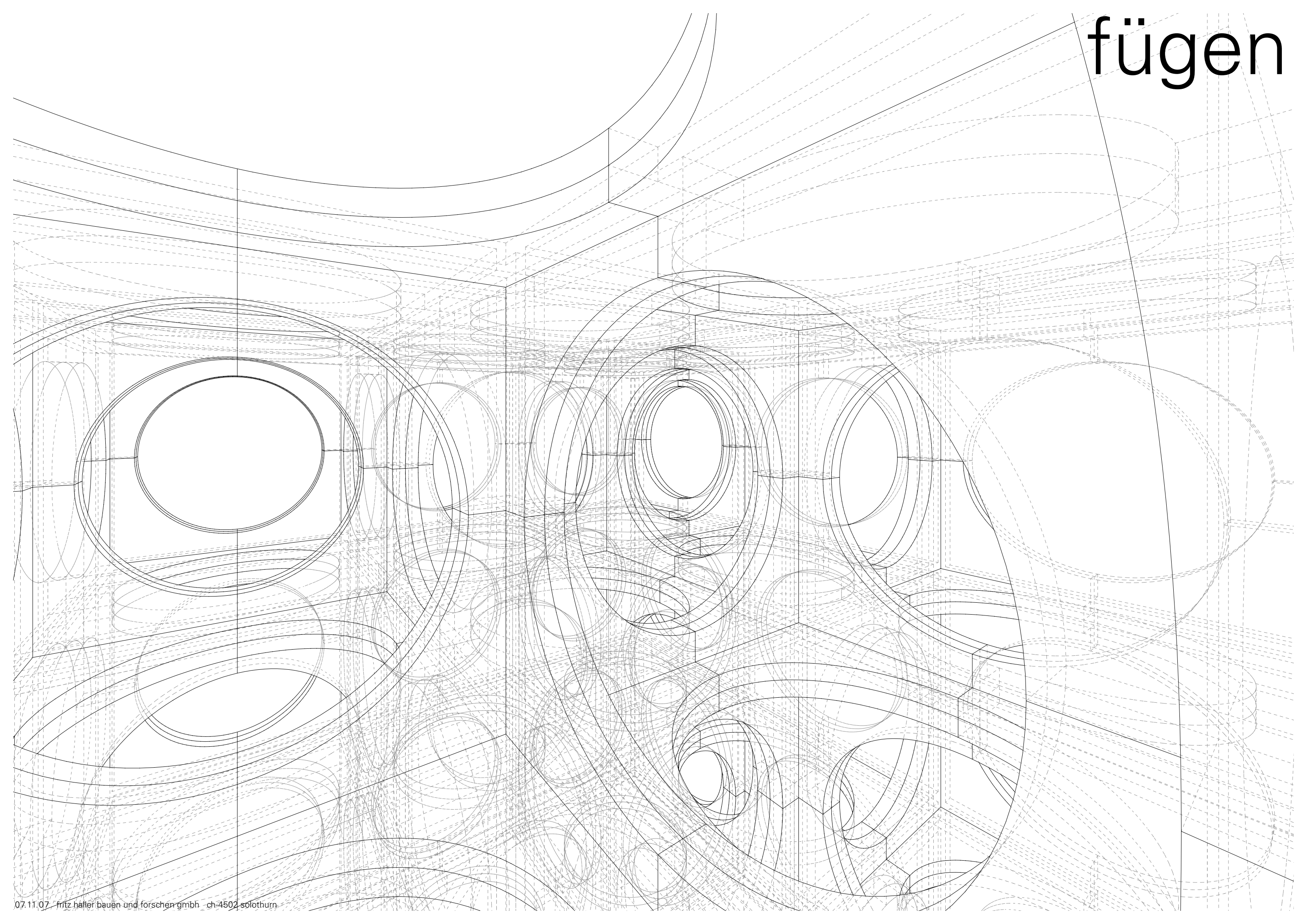

stabwerk

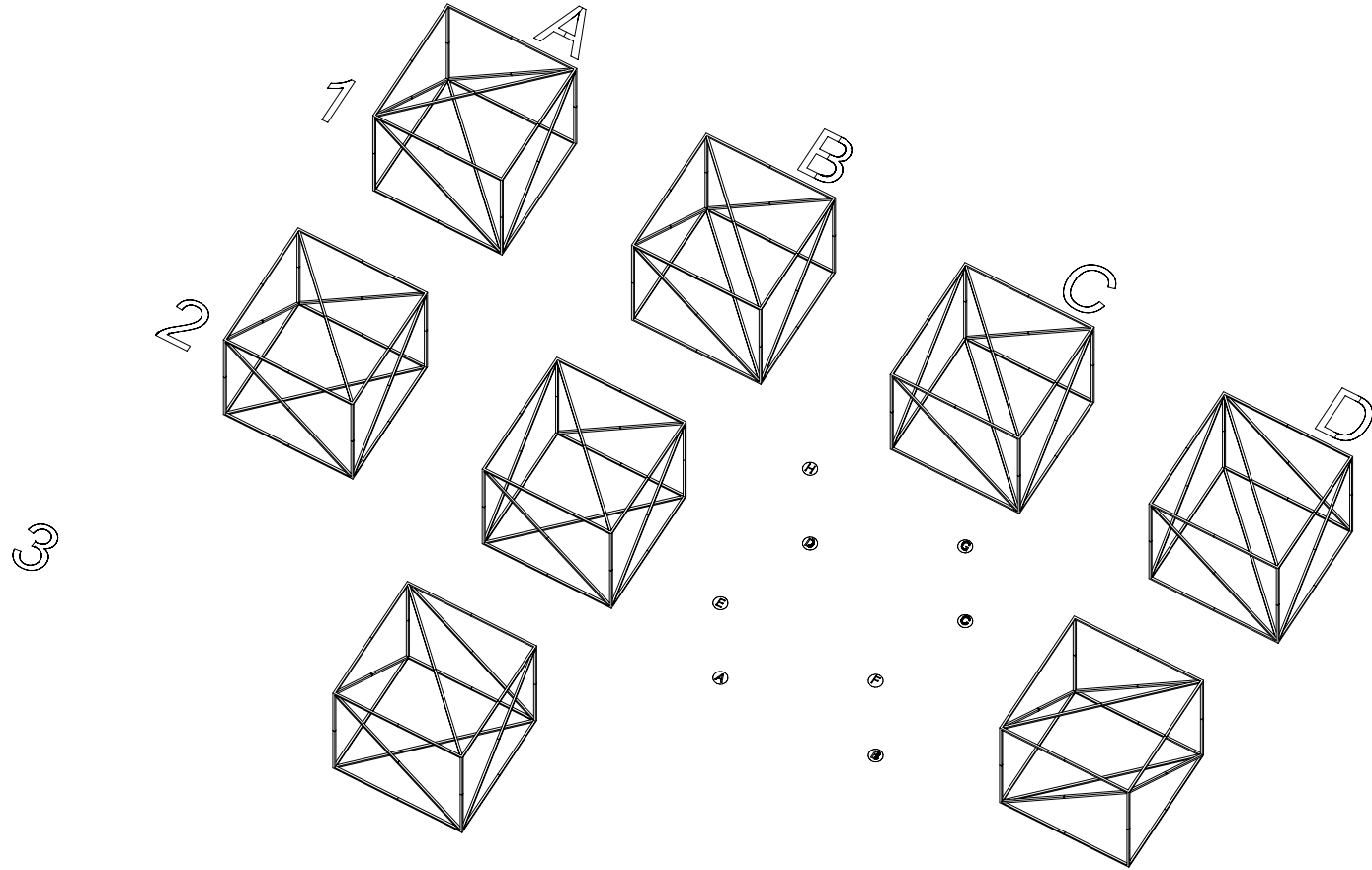

plattenbaukasten

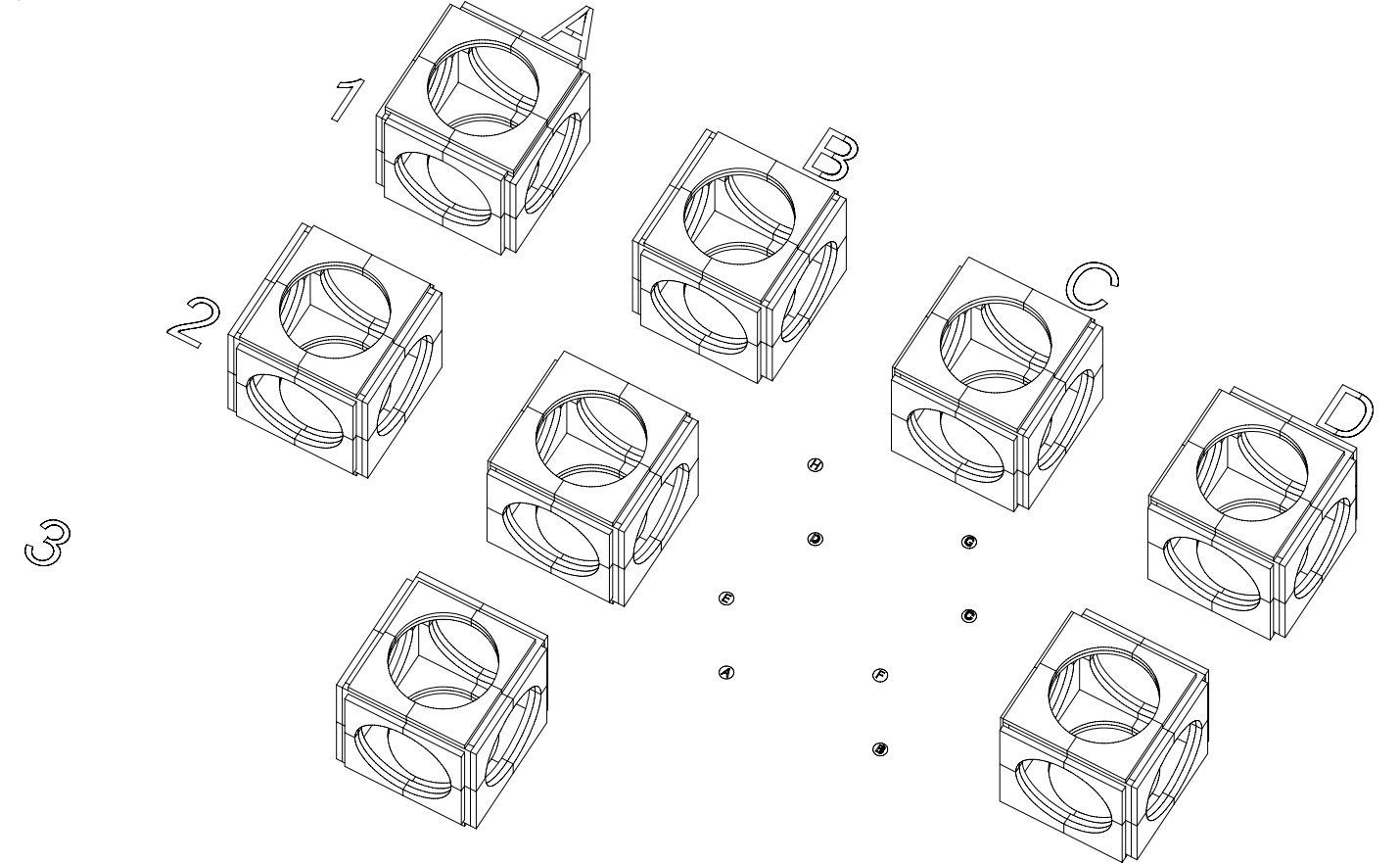

holzwürfel

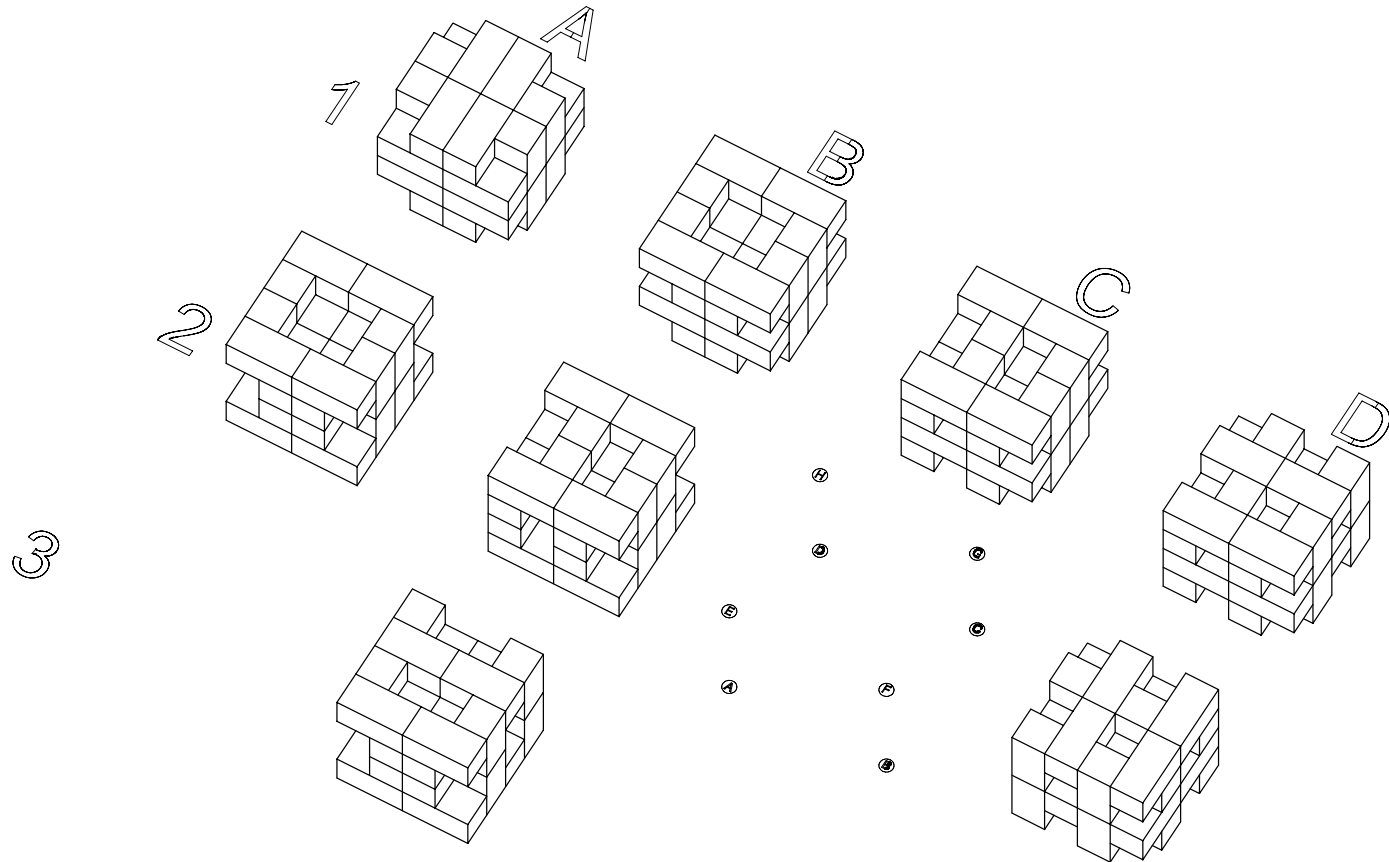

vektordiagramm

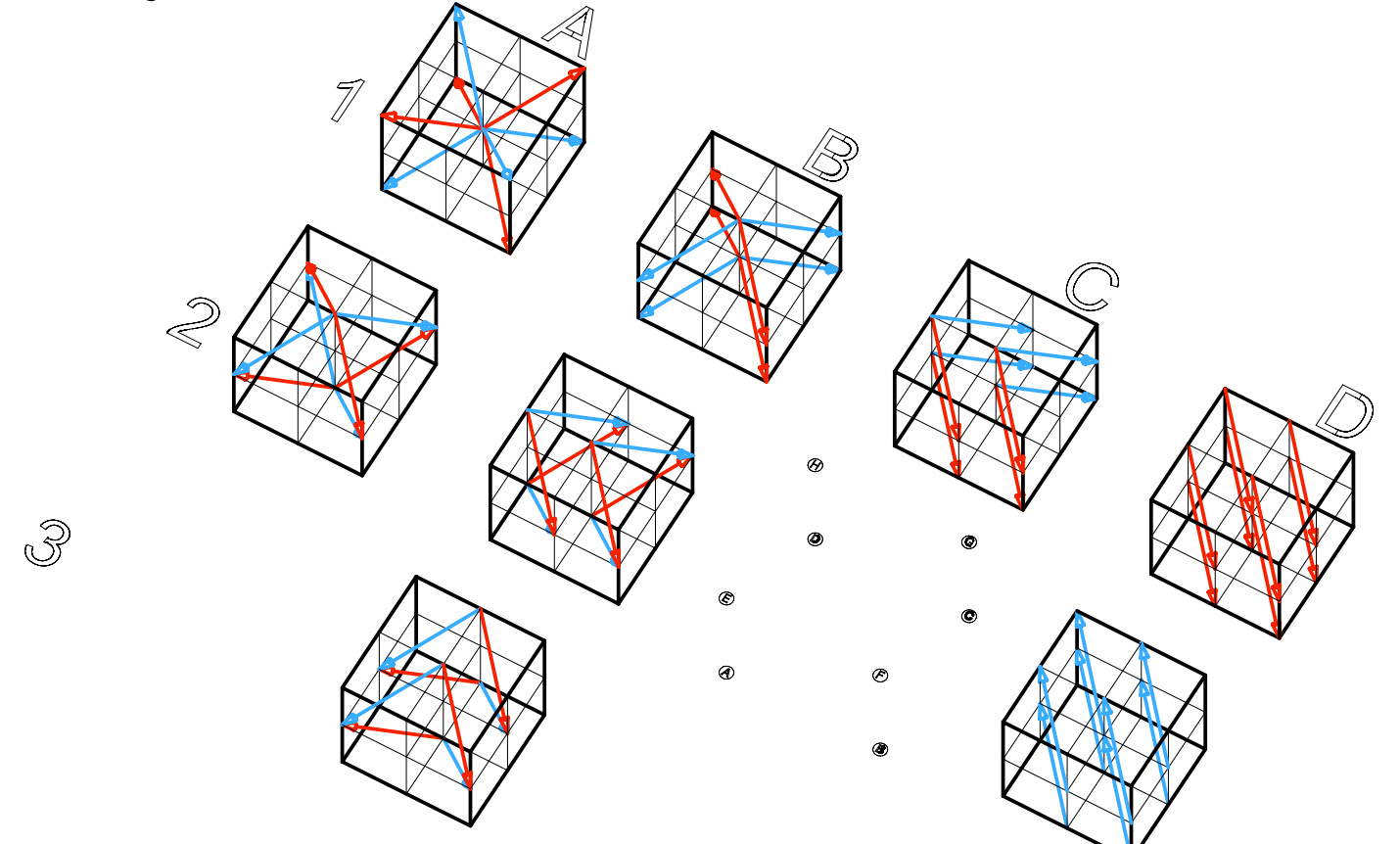

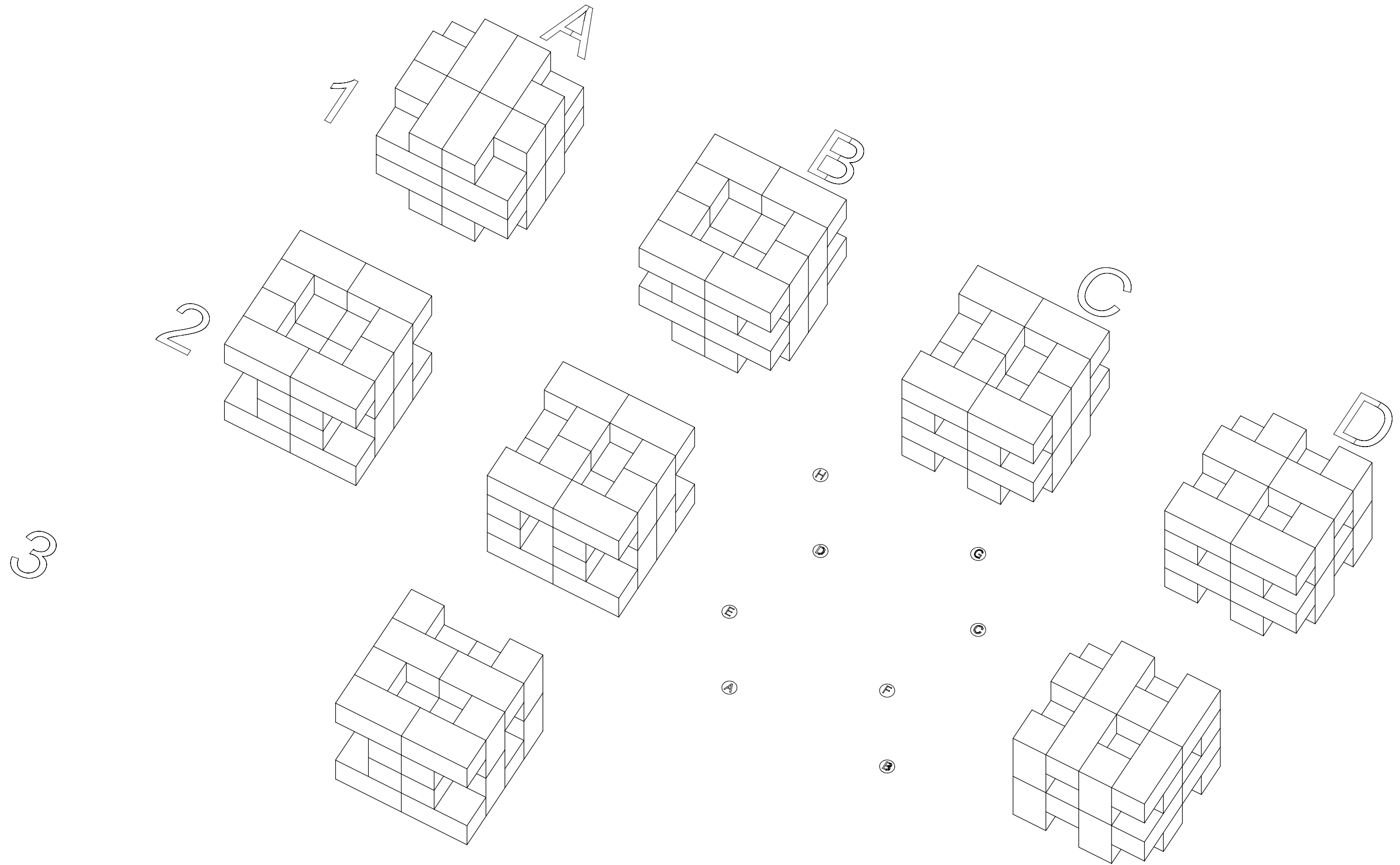

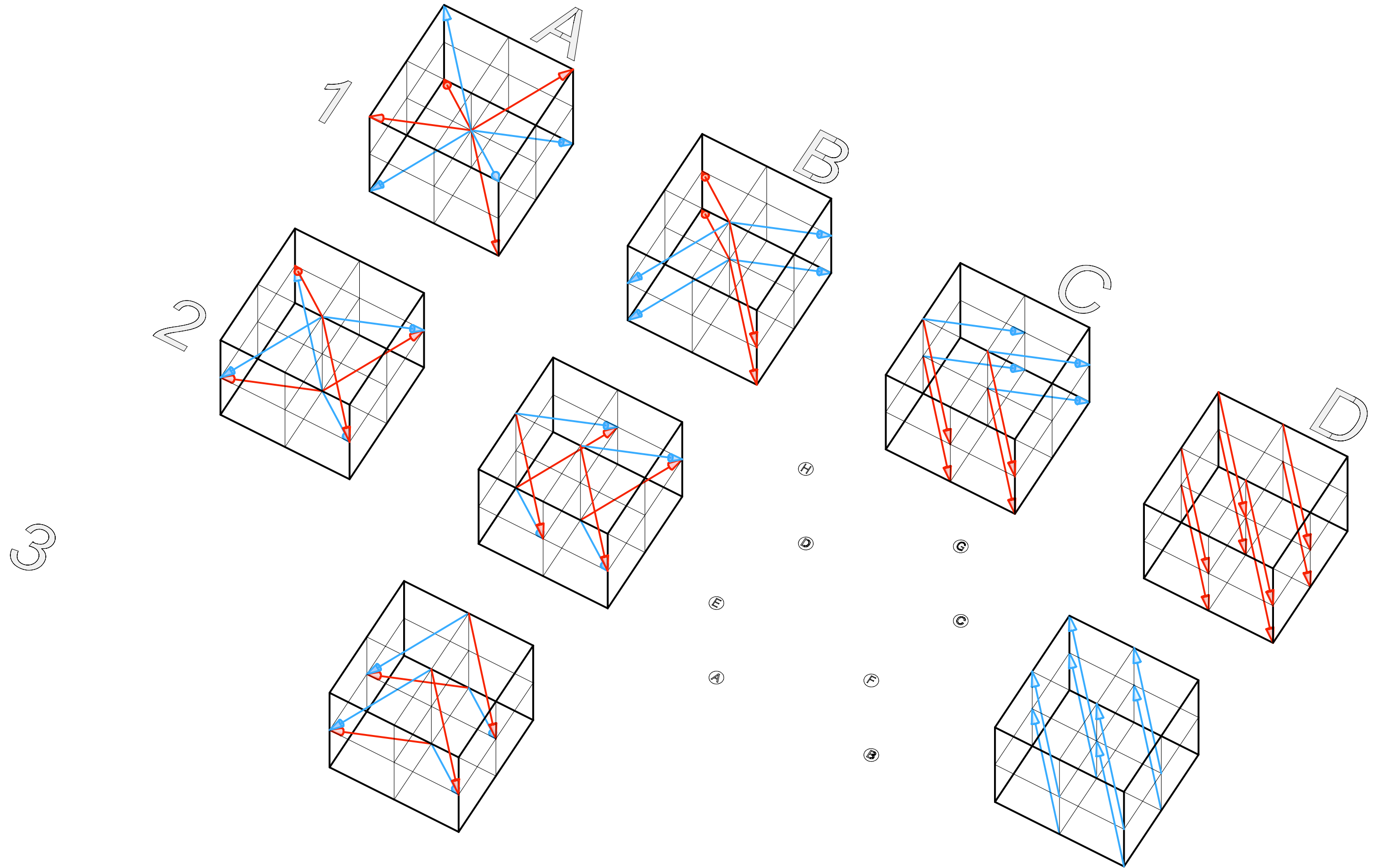

vektordiagramm
würfelmodell
plattenbaukasten
stabwerkmodell

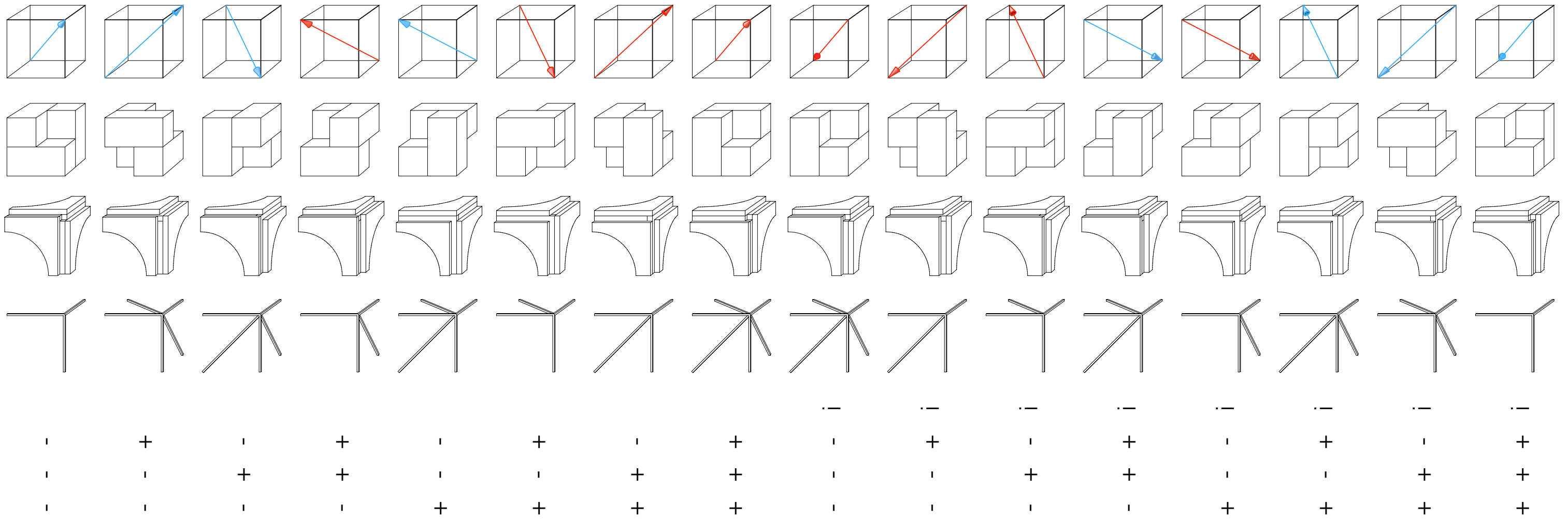

beispiel 1
kubusA1
im zentrum

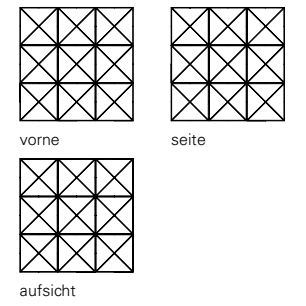
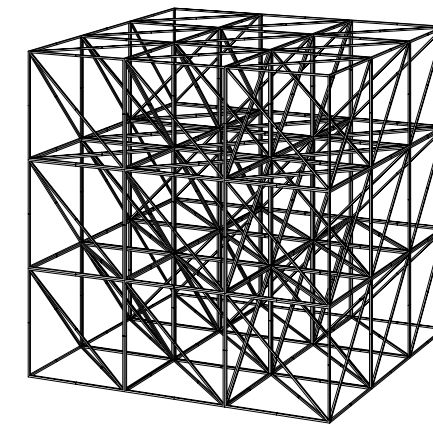
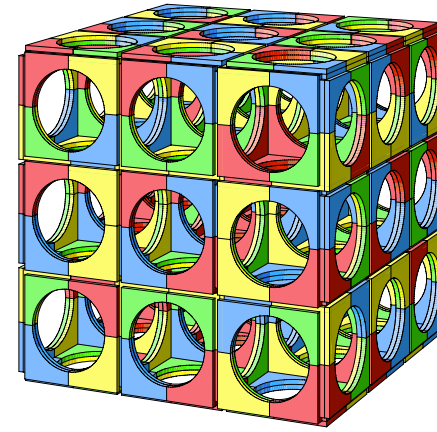
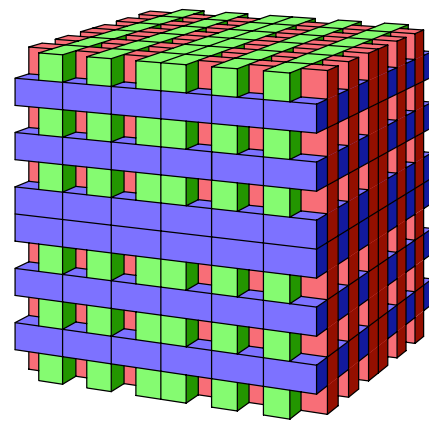
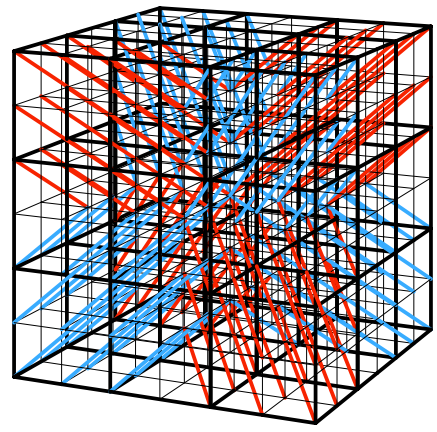
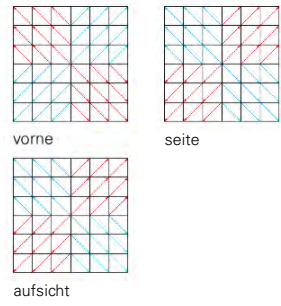

beispiel 2
kubusA2
im zentrum

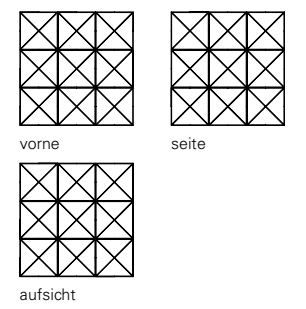
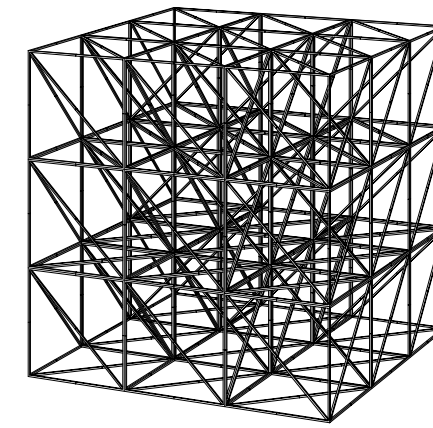
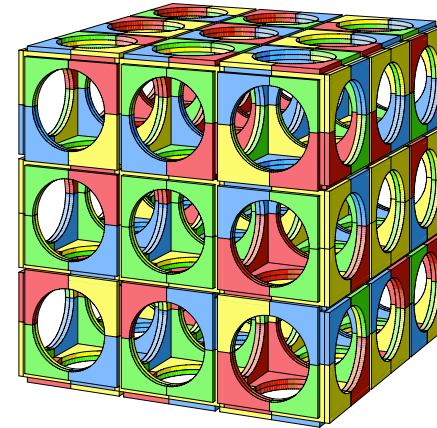
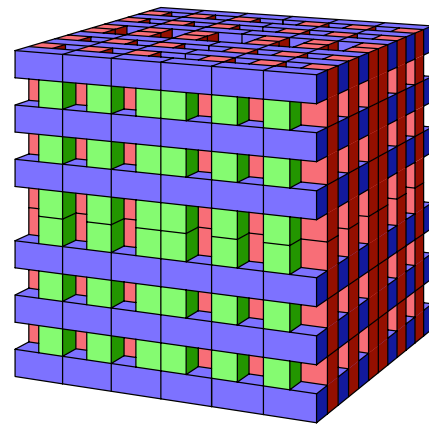
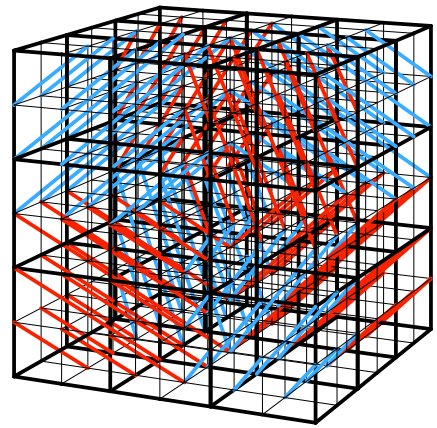
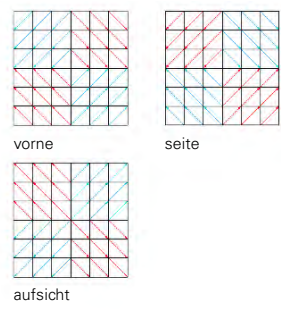

beispiel 3
kubusA1
in allen 27zellen

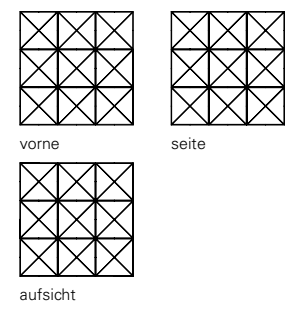
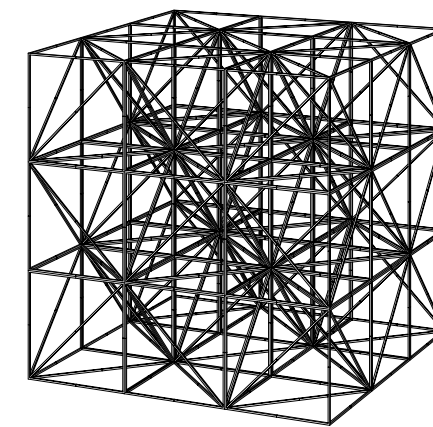
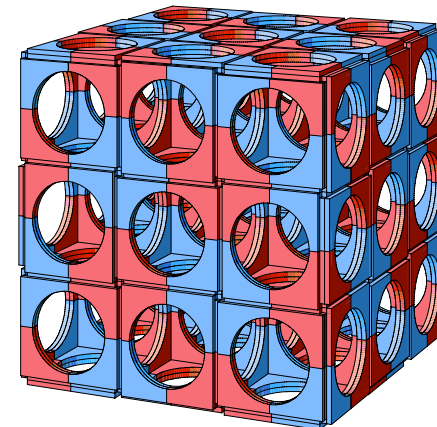
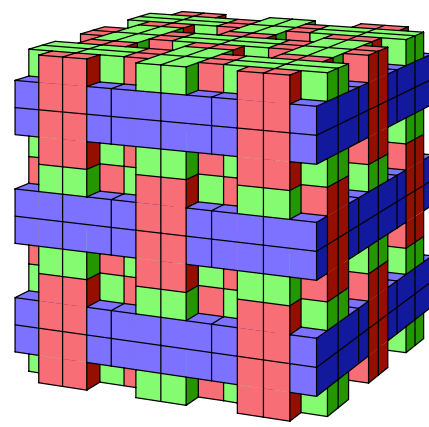
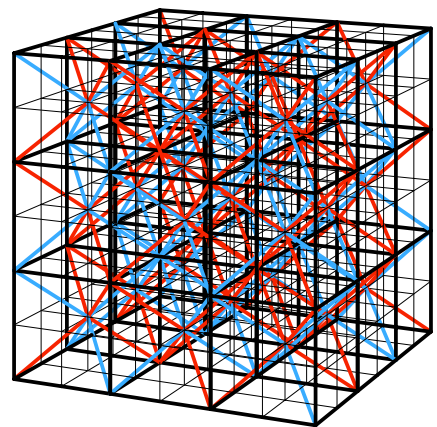
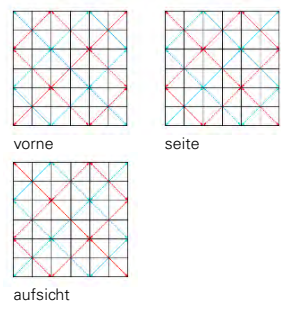

beispiel 4
kubusD1
in allen 27zellen

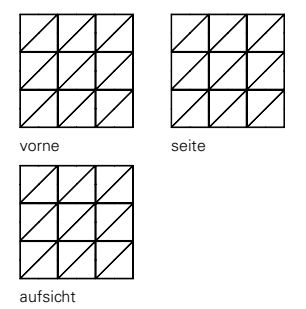
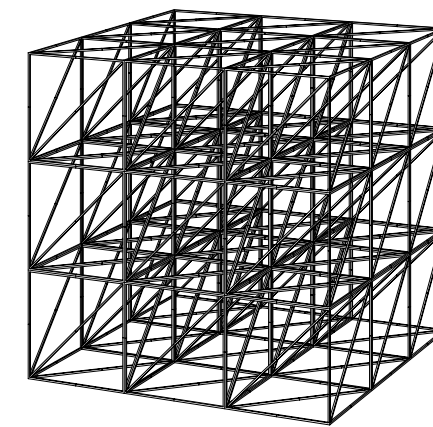
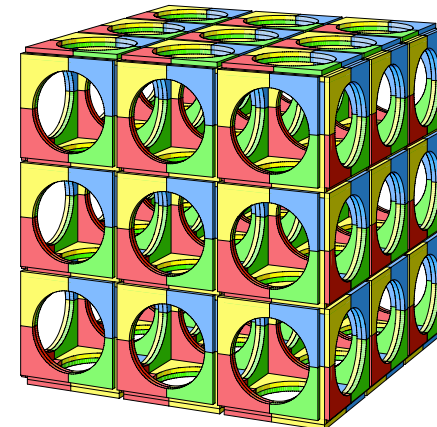
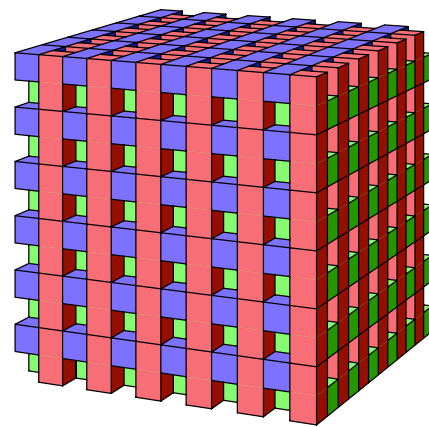
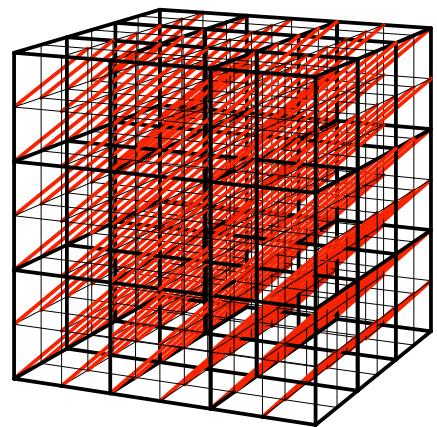
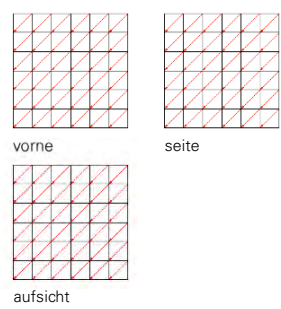

vektorendiagramm

holzwürfel

plattenbaukasten

stabwerk